

TECHNICAL INFORMATION

LED



Table of contents

1. Characteristics and use	2
1-1. LED basic structure	2
1-2. Characteristics	2
Forward current vs. forward voltage / Radiant output power vs. forward current	
1-3. Operation	3
DC drive / Pulse drive	
1-4. Performance deterioration	4
Method for calculating the deterioration rate	
1-5. How to measure radiant output power	5
Radiant flux (radiant output power) / Radiant illuminance	
2. Application examples	5
2-1. Encoders	5
2-2. Optical switches	6
2-3. Light sources for object detection	7
2-4. Distance measurement	7
2-5. Optical communications	7
3. Precautions for use	7
3-1. Precautions for storage	7
3-2. Precautions during transportation	7
3-3. Precautions for mounting	7
Lead forming / Cutting off the leads / Soldering	
3-4. Cleaning	8
3-5. Others	8
Measures against static electricity / Driving the device	

1. Characteristics and use

This section describes structures and characteristics of typical LEDs available from HAMAMATSU, as well as how to use them.

1-1 LED basic structure

To form LED chips, processes such as diffusion and vacuum evaporation are applied to a LED wafer having internal PN junctions and ultimately the wafer is diced into individual chips. Typical LED structures are shown in Figure 1-1.

LED wafers are fabricated by using the liquid or vapor phase epitaxy technique.

The drawing on the left in Figure 1-1 shows a chip using a wafer fabricated by liquid phase epitaxy of GaAlAs on a GaAs crystal substrate. Since the GaAs substrate absorbs light, the GaAs substrate is removed in most cases to ensure a high-power LED.

Liquid phase epitaxy is difficult for InGaAsP (drawing on right in Figure 1-1) which is used as a material for longer wavelength LEDs. HAMAMATSU uses vapor phase epitaxy to fabricate this type of LED. Unlike liquid phase epitaxy, the vapor phase epitaxy technique cannot fabricate thick epitaxial growth layers, but thin layers with controlled thickness can be formed. This allows fabricating light-reflecting layers by repeatedly forming thin layers. HAMAMATSU utilizes these techniques to develop new high-power LEDs.

[Figure 1-1] LED chip structure

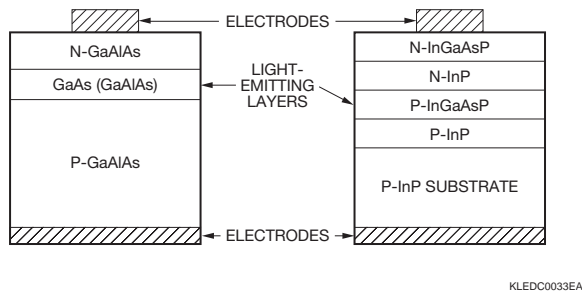

Note: Actual thicknesses of each layer will differ from those shown above.

A typical LED chip is die-bonded to a gold-plated metal base or silver-plated lead frame and electrically connected by gold wires to the wire leads. The wires are then protected by applying a plastic coating or sealing them with caps. Figure 1-2 shows a chip assembled on a metal base.

[Figure 1-2] LED chip assembly

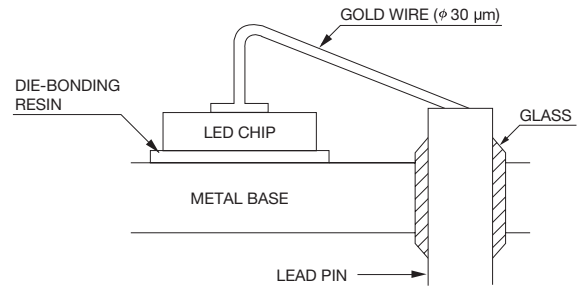

KLEDC0004EA

To enhance radiant power, some LEDs use a metal base with a concave area which serves as a reflector, and the LED chip is mounted as shown in Figure 1-3.

[Figure 1-3] LED chip mount example

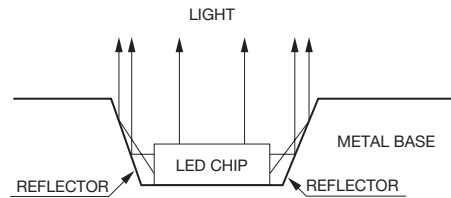

KLEDC0005EA

1-2 Characteristics

Forward current vs. forward voltage

The LED has forward current vs. forward voltage characteristics similar to those of rectifier diodes. The characteristic curves of individual LED types differ slightly, depending on the element structure and other factors. (See Figure 1-4 below.)

[Figure 1-4] Forward current vs. forward voltage

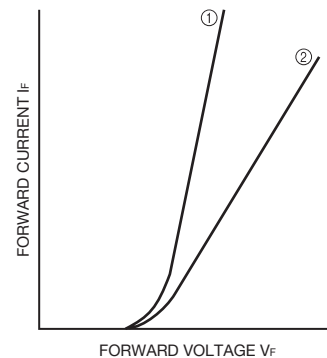

KLEDC0006EA

Curve ① shows typical characteristics of a low-resistance LED. Compared to curve ② which is a normal LED, it is

clear that the forward voltage (V_F) required to produce the same current value is lower. “Resistance” referred to here does not mean the term commonly used for “electrical resistance” but instead indicates the slope of a tangent for the characteristic curve at the specified current or voltage (differential resistance). In general, using an LED with a lower V_F allows easier circuit design. If using an LED with a larger V_F , the power consumption will be larger when operated at the same current value. This will cause a subsequent temperature rise in the LED, resulting in detrimental effects such as a decrease in the output power, peak emission wavelength shift and deterioration of the LED.

■ Radiant output power vs. forward current

The radiant output power vs. forward current characteristics show a linear line up to the maximum rating. Therefore, if the radiant power at a certain current value is measured, the approximate radiant power at a different current value can be easily estimated. However, if the temperature of the emission area increases due to the ambient temperature and heat generated from the LED chip itself, the radiant power decreases and saturation is seen in the characteristic graph. In pulsed operation, the saturation state varies according to the pulse width and duty ratio.

1-3 Operation

■ DC drive

When using an LED in optical switch applications, the most common method is DC drive using a forward current. In this method, care should be taken not to allow the forward current to exceed its absolute maximum rating for the LED. If the ambient temperature of the LED is high, it is necessary to take into account the allowable forward current vs. ambient temperature characteristics.

[Figure 1-5] Example of DC drive circuit

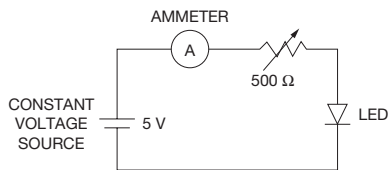

KLEDC0007EA

Figure 1-5 shows the simplest circuit. When a constant current of 20 mA is to flow in this circuit, first set the variable resistor to the maximum resistance position and apply the voltage. Then, observing the ammeter, gradually reduce the resistance of the variable resistor until the current reaches

20 mA. If no variable resistor is used, the resistance value should be calculated. For example, if the forward voltage at 20 mA is 1.4 V, the resistance R is given by: $R = (5.0 \text{ V} - 1.4 \text{ V}) / 0.02 \text{ A} = 180 \Omega$. Thus a 180 Ω resistor should be used.

With the circuit shown in Figure 1-5, the forward current slightly varies according to fluctuations in the forward voltage of the LED. To prevent this, a constant current circuit using an op amp is suggested. Figure 1-6 shows a simple constant current circuit using an op amp.

[Figure 1-6] Example of constant current circuit using op amp

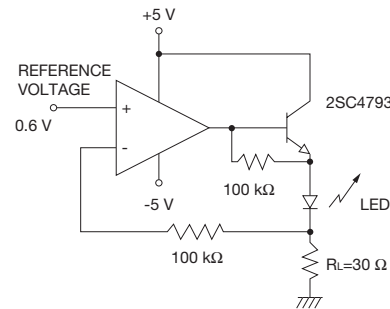

KLEDC0008EB

In the case of Figure 1-6, a reference voltage of 0.6 V is applied to the positive phase input terminal (+) of the op amp. Because the potential of the negative phase input terminal (-) becomes nearly equal to this reference voltage, the voltage drop at both ends of load resistance R_L will be 0.6 V, and a resultant current of 20 mA ($0.6 \text{ V} / 30 \Omega = 20 \text{ mA}$) flows through the LED. Thus it is possible to select the desired LED drive current by changing the value of reference voltage.

■ Pulse drive

In pulse drive, the current value should not exceed the absolute maximum ratings. The simplest pulse drive is when the output from a pulse generator is directly fed into both ends of the LED. However, this method is usually insufficient in terms of current capacity. In such cases, the use of a transistor is recommended, as shown in Figure 1-7.

[Figure 1-7] Example of pulse drive circuit

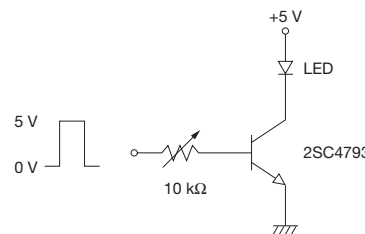

KLEDC0009EB

In addition, a high-speed driver is required when driving the LED in high-speed pulse mode. Figure 1-8 shows a typical circuit using a high-speed driver.

[Figure 1-8] Example of high-speed pulse drive circuit

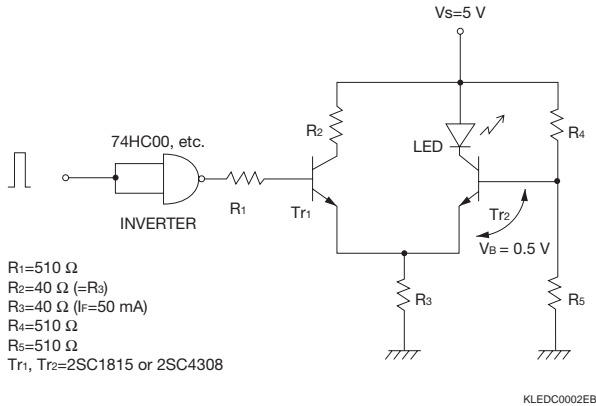

In the circuit shown in Figure 1-8, the LED turns on when the input is at the High level. The forward current I_F which flows through the LED can be obtained in " $I_F = (V_s/2 - V_B)/R_3$ " [With this circuit, $I_F = (5/2 - 0.5)/40 = 0.05$ A] The response speed is determined by the time response of Tr_1 and Tr_2 . It will be about 20 MHz if 2SC1815 is used, and about 100 MHz if 2SC4308 is used.

1-4 Performance deterioration

When an LED is used for long periods of time, performance deterioration may take place. Common deterioration phenomena include a decrease in the output power and variations of the forward voltage. It is thought that these deteriorations result from the crystal dislocation and shift caused by heat generation in the emission area. These can be observed as a dark line or dark spot in the emission pattern.

Deterioration may possibly occur from an external stress. If the LED is driven with stress applied to the LED chip, its performance may unduly deteriorate. This stress may also issue from mechanical distortion on the package. Sufficient care must be exercised when mounting the LED.

Method for calculating the deterioration rate

In general, the LED radiant output (P) decreases exponentially with operating time, as expressed in the equation below.

$$P = P_o \times \exp(-\beta t) \dots\dots\dots (1)$$

P_o : Initial radiant output power
 β : Deterioration factor
 t : Operating time

The deterioration factor (β) depends on the element material, structure and operating conditions, and is usually assumed as follows:

$$\beta = \beta_o \times I_F \times \exp(-E_a/kT_j) \dots\dots\dots (2)$$

β_o : Deterioration constant (inherent to LED)
 I_F : Operating current [A]
 E_a : Activated energy [eV]
 k : Boltzmann constant (8.62×10^{-5}) [eV/k]

In Equation (2), the deterioration factor β includes I_F added to the Arrhenius equation which relates to emitting layer temperature. As stated, the deterioration is caused by the dislocation and shift in the crystal. Equation (2) is based on the assumption that the dislocation and shift result from recombination energy not contributing to emission as well as from the lattice vibration due to temperature.

The emitting layer temperature (T_j) is given by the equation below.

$$T_j = (R_{th} \times I_F \times V_F) + T_a \dots\dots\dots (3)$$

R_{th} : Thermal resistance [$^{\circ}C/W$]
 V_F : Forward voltage [V]
 T_a : Ambient temperature [K]

From the life test data measured under certain conditions, the deterioration factor under other conditions can be figured out using Equations (1), (2) and (3). For example, if we have the life test data measured at DC 50 mA for up to 3000 hours, β can be obtained using Equation (1). With this β and Equation (1), the extent of deterioration after 3000-hour operation under the same conditions can be estimated. In contrast, to calculate the life data of the same LED operated under different conditions, β_o should be obtained by substituting both T_j obtained from Equation (3) and β obtained previously for Equation (2). Then substituting the test conditions for Equation (2) gives the deterioration factor β .

The activated energy E_a usually used is 0.5 to 0.8 eV and the thermal resistance ranges from 300 to 350 $^{\circ}C/W$ for a TO-18 (TO-46) package.

The calculation results from equations (1), (2) and (3) should be used for reference only. Equation (2) takes only the deterioration by heat into account and does not give any consideration to stress deterioration and breaking mode that may occur if the specified rating is exceeded. Equation (2) is therefore unlikely to hold true particularly at low temperatures where stress deterioration cannot be ignored.

1-5 How to measure radiant output power

■ Radiant flux (radiant output power)

For radiant flux measurement, the full radiant output power is measured when a specified forward current flows into the LED. To measure the radiant power emitted in the horizontal direction, a reflector is provided as shown in Figure 1-9, so that the entire radiant power emitted in every direction from the LED can be detected by a photodiode placed in front of the LED. The total radiant power emitted from the LED is then measured based on the photodiode photo sensitivity at the peak emission wavelength of LED.

[Figure 1-9] Measurement method for radiant output power

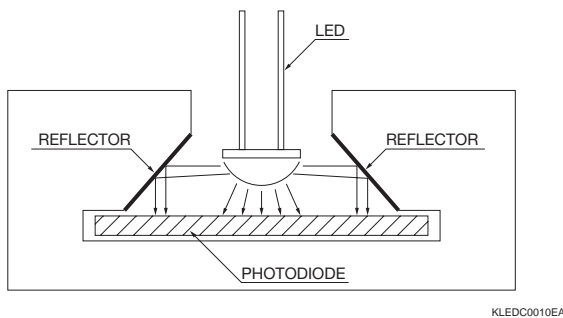

■ Radiant illuminance

Radiant illuminance is the radiant power striking a surface per unit area (1×1 cm) located 2 cm away from the LED emitting area. The light distribution within a unit area might not be uniform if the LED has a narrow directivity. However, as a general guide, this measurement is enough to compare the radiant power between LEDs.

2. Application examples

2-1 Encoders

In FA (Factory Automation) equipment where high-speed and precise control down to the nano level are required, rotary encoders are now being manufactured that are capable of angular detection to 16 millionths of a single rotation. The rotary encoder contains a rotating disk and a stationary disk, both with slits formed at a fine pitch. Photodiodes in the rotary encoder detect the passage or blockage of LED light from the mutual interaction of the two slit disks to find the angle. These photosensors are positioned in complex patterns to find angles with high precision, so it is important that the light hits the photosensors uniformly.

Poorly collimated light (light that is not parallel enough) causes the following problems. A portion of this type of light is blocked at positions where the light should penetrate completely through (See left drawing in Fig. 2-1). This lowers the signal amplitude so the detection capability decreases. Another problem is that light leakage occurs at positions where the rotating slit disk should be blocking light from the stationary slit disk (See right drawing in Fig. 2-1).

To prevent these problems, high precision encoders have to use a “collimated LED” that emits the collimated light uniformly with minimal convergence and dispersion. These collimated LEDs in most cases use an LED chip having a so-called current confinement structure with a small light emission diameter. However, chips with this current confinement structure are subject to a problem called “sudden death” where rapid deterioration occurs. HAMAMATSU collimated LEDs eliminate this problem since they do not use a current confinement structure. Our collimated LEDs deliver a high degree of parallel light by means of a special design that optimizes the lens contour, and ensure high reliability.

[Figure 2-1] Concept drawing of LED emitting poorly collimated light

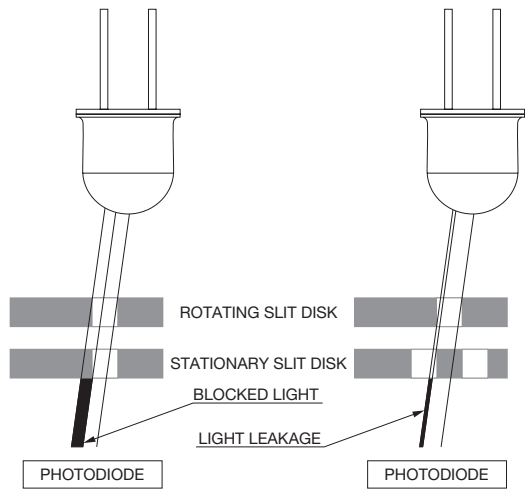

KLEDC0035EA

[Figure 2-2] Concept drawing of LED emitting highly collimated light

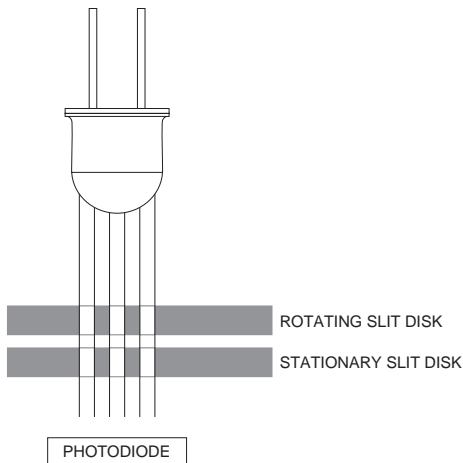

KLEDC0034EA

2-2 Optical Switches

Optical switches are used for detecting objects without actually contacting them. In transmission type optical switches, an LED and a photodiode are arranged facing each other across the path of the object. When an object passes between them and blocks the LED light, it is detected. Reflective type optical switches, in which an LED and a photodiode are arranged on the same side, detect an object when it reflects the LED light back to the photodiode.

[Figure 2-3] Transmission type optical switch

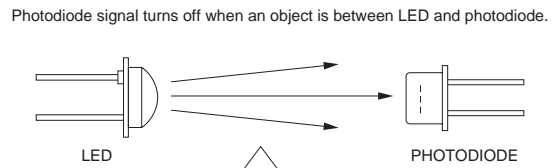

KLEDC0036EA

[Figure 2-4] Reflective type optical switch

Photodiode signal turns off when there is no object.

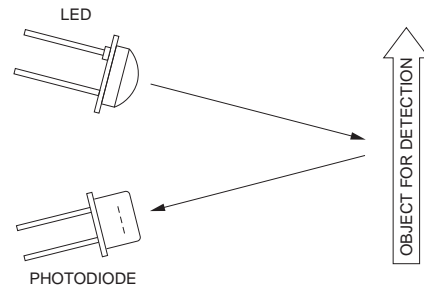

KLEDC0037EA

Various types of LEDs are available for optical switches. Red LEDs are used to make the optical axis easy to align as well as to let people know the sensing status.

The “brightness” visible to the human eye and the “light output” measured with a photodiode might not always match each other. HAMAMATSU provides red LEDs that emit light at 670 nm wavelengths which are easy to see and also deliver a large light output.

In most applications including security applications requiring invisible light, near infrared LEDs that emit a large light output are usually used. By using a large projection lens, even ordinary LEDs can project a light beam more than 100 meters if needed. HAMAMATSU also offers LEDs that beam a large amount of light into the projection lens (incident angle: approx. 60°) by using a reflector structure (See Figure 2-5.) that makes effective use of light emitted from the side of the chip.

[Figure 2-5] LED with reflector structure

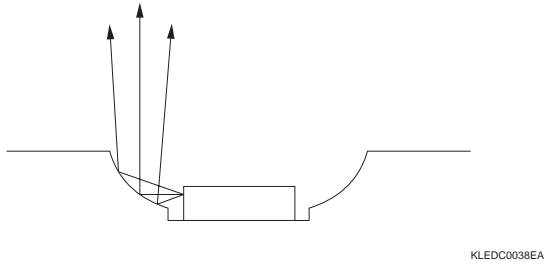

Recently, there are an increasing number of methods for making optical switches provide distance or ranging information. An object at a specified position can be detected by using photosensors such as PSD (Position Sensitive Detectors) or dual photodiodes capable of detecting a spot light position. This method has no faulty detection problems even if the object passes behind the detection area. LEDs with a small light emission diameter prove more effective when using PSD or dual photodiodes.

2-3 Light sources for object detection

LEDs are also being used in recent years as light sources for rice sorting machines. Heat emitted from an LED during operation is small compared to that of incandescent lamps, so that the LED exerts virtually no heat effect on the grains of rice during sorting.

Infrared LEDs and red LEDs are used as a light source for CCD cameras. Handheld barcode readers, for example, mainly use multiple red LEDs. Pen type barcode readers use a single set of an LED and a photodiode.

2-4 Distance measurement

LEDs are also being used in optical distance meters that utilize the phase difference of an optical path. Optical distance meters make use of a principle that measures distance by means of the phase differential between the forward and return paths of the light. High-speed response LEDs are used here since boosting the distance measurement accuracy requires high-speed modulation.

2-5 Optical communications

HAMAMATSU is making continual progress in developing high-speed and high-power LEDs for applications such as communications via POF (Plastic Optical Fibers) and VICS (Vehicle Information and Communication System).

3. Precautions for use

3-1 Precautions for storage

To protect the terminal leads from oxidation and stain, carefully store LEDs in places where moisture condensation and water leakage do not occur, and corrosive gases are not present. Particularly for plastic package products with silver-plated leads, store them in a desiccator (preferably with nitrogen flow) to prevent the package from absorbing moisture.

3-2 Precautions during transportation

Protect the light emitter from mechanical vibrations and shocks. The terminal leads might be deformed if they undergo strong vibrations and shocks.

3-3 Precautions for mounting

Do not allow any hard or sharp objects to touch the plastic package and epoxy-resin window as they are easily scratched.

■ Lead forming

To form the leads, hold the roots of the leads securely and bend them so that no force is applied to the package. Lead forming should be done before soldering.

■ Cutting off the leads

If leads are cut when still at a high temperature, this may cause an electrical discontinuity. Always cut off the leads when they are at room temperature. Never cut off the leads just after they have been soldered.

■ Soldering

Using a low-temperature melting solder (below 200 °C), solder the leads at the temperature and time specified in Table 1 below. If these conditions cannot be met, it is recommended that some form of heat sinking be used at the base of the lead so that the solder heat is not conducted to the package. Soldering at excessive temperatures and times may cause the plastic package to melt or crack, resulting in performance deterioration. This sometimes leads to wiring breakage. If the leads are soldered while external force is applied to the device, the residual force tends to degrade the device performance. Care should also be taken not to apply force to the leads during soldering.

Product name	Maximum soldering temperature	Maximum soldering time
Plastic package LED	230 °C	5 seconds (1 second *)
Metal package LED	260 °C	5 seconds (1 second *)

* For devices having a lead length less than 2 mm

Do not use any flux which is highly acidic, alkaline or inorganic because it may cause the part leads to erode. Use a rosin flux.

3-4 Cleaning

Use alcohol for cleaning. When carrying out ultrasonic cleaning, stress applied to the device greatly depends on the size of the cleaning bath, the output of the vibrator, the size of the board to which the device is attached, and the attachment method of the device. Thus, take into account these factors to confirm the acoustic forces applied to the device prior to the actual cleaning.

3-5 Others

Measures against static electricity

Static electricity charges from the human body or surge voltages from measuring equipment may degrade the performance of L7850 series, L7866, L8245 LEDs, possibly leading to permanent damage. Therefore, the operator, worktable, and measuring equipment, etc. must be grounded to prevent such static electricity and surge voltage from being applied to the device.

Drive condition setting

When driving a device, always observe the absolute maximum ratings. If an LED is driven under conditions exceeding the absolute maximum ratings, the LED may deteriorate or break down. Use caution to avoid supplying a forward current or applying a reverse voltage that exceeds the ratings. The LED must also be protected against surges from the power supply.