

Mini-spectrometer



[SMD series]

C14384MA-01

**High sensitivity in the near infrared region (to 1050 nm),
ultra-compact grating type spectrometer**

The C14384MA-01 is a ultra-compact grating type spectrometer that provides high sensitivity in the near infrared region. As such, it is capable of acquiring continuous spectrum. The product has been downsized through Hamamatsu unique optical design, which helps to further reduce the size of mobile devices.

Features

- Ultra-compact: 11.5 × 4.0 × 3.1 mm^{*1}
- Ultra-lightweight: 0.3 g
- Spectral response range: 640 to 1050 nm
- High sensitivity: 50 times ($\lambda=1000$ nm) the previous product (C11708MA)
- Flexible cable included

Applications

- Food inspection (sugar content, moisture, fat)
- Light level measurement
- Component analysis

Structure

Parameter	Specification	Unit
Image sensor	High-sensitivity CMOS linear image sensor with a slit	-
Number of pixels	256 (including optical black) ^{*2}	Pixels
Pixel size (H × V)	7 to 14.4 ^{**3} × 200	μm
Slit ^{*4} (H × V)	15 × 300	μm
NA ^{*5}	0.22	-
Package ^{*6}	Plastic with flexible cable	-
Dimensions (W × D × H) ^{*1}	11.5 × 4.0 × 3.1	mm
Weight	0.3	g

*1: Flexible cable not included

*2: Number of effective pixels=192 (pixel no. 65 to 256)

*3: Varies depending on the pixel

*4: Light-incident aperture size

*5: Numeric aperture (solid angle)

*6: This product is not hermetically sealed. Do not immerse in cleaning fluid or the like. If you do, the fluid may penetrate inside and damage the product.

Absolute maximum ratings (Ta=25 °C unless otherwise noted)

Parameter	Symbol	Condition	Values	Unit
Supply voltage	Vs max		-0.3 to +6	V
Clock pulse voltage	V(CLK)		-0.3 to +6	V
Start pulse voltage	V(ST)		-0.3 to +6	V
Operating temperature	Topr	No dew condensation ^{*7}	+5 to +50	°C
Storage temperature	Tstg	No dew condensation ^{*7}	-20 to +70	°C

*7: When there is a temperature difference between a product and the surrounding area in high humidity environment, dew condensation may occur on the product surface. Dew condensation on the product may cause deterioration in characteristics and reliability.

Note: Exceeding the absolute maximum ratings even momentarily may cause a drop in product quality. Always be sure to use the product within the absolute maximum ratings.

Recommended terminal voltage (Ta=25 °C)

Parameter	Symbol	Min.	Typ.	Max	Unit
Supply voltage	Vs	4.75	5	5.25	V
Clock pulse voltage	High level	Vs - 0.25	Vs	Vs + 0.25	V
	Low level	0	-	0.3	
Start pulse voltage	High level	Vs - 0.25	Vs	Vs + 0.25	V
	Low level	0	-	0.3	

Electrical characteristics [Ta=25 °C, Vs=5 V, V(CLK)=V(ST)=5 V]

Parameter	Symbol	Min.	Typ.	Max	Unit
Clock pulse frequency	f(CLK)	0.2	-	5	MHz
Video rate	VR	-	f(CLK)	-	Hz
Output impedance*8	Zo	-	150	-	Ω
Current consumption*9	I	-	20	-	mA

*8: Video signal output terminal (5-pin)

An increase in the current consumed at the video terminal causes the chip temperature to increase, which also increases the dark current. Therefore, connect a buffer amplifier to the video output terminal, and keep the current from flowing as much as possible.

*9: f(CLK)=5 MHz

Electrical and optical characteristics [Ta=25 °C, Vs=5 V, V(CLK)=V(ST)=5 V]

Parameter	Symbol	Min.	Typ.	Max	Unit
Conversion efficiency	CE	-	50	-	μV/e ⁻
Dark output voltage*10	Vd	-	0.4	4.0	mV
Saturation output voltage*11	Vsat	3.6	4.3	4.7	V
Readout noise	Nr	0.2	0.8	2.4	mV rms
Output offset voltage	Vo	0.3	0.5	0.9	V
Spectral response range	λ	-	640 to 1050	-	nm
Spectral resolution (FWHM)	640 to 800 nm	-	20	25	nm
	800 to 1050 nm	-	17	20	
Wavelength reproducibility*12	λr	-0.5	-	+0.5	nm
Wavelength temperature dependence	λTd	-0.1	-	+0.1	nm/°C
Spectral stray light*13	SL	-	-	-23	dB

*10: Integration time=10 ms

*11: Relative value with output offset voltage Vo as the reference

Example: When output offset voltage Vo is 0.5 V and saturation output voltage Vsat is 4.3 V, the saturation voltage at the video signal output terminal is 4.8 V.

*12: Measured under constant light input conditions

*13: The ratio of the count measured when a line spectrum (850 nm) is input to the count measured when an 850 ± 40 nm light is input

Structure

Smaller mini-spectrometers

■ MS series

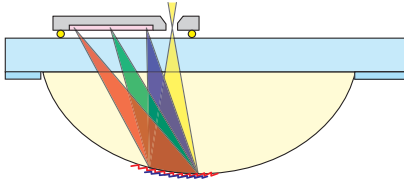

KACCC0922EA

The glass used does not expand easily with rising temperatures, so the temperature dependency of the wavelength is extremely small.

■ Micro series

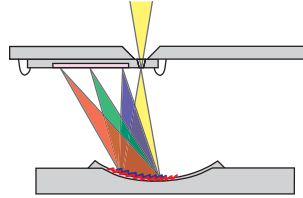

KACCC0923EA

The metal package provides high humidity resistance. Low cost is achieved because it is a hollow type.

■ SMD series

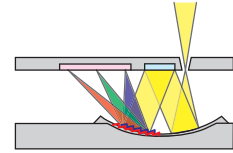

KACCC0924EA

Being ultra-compact, it can be integrated into mobile devices and drones.

Spectral response (typical example)

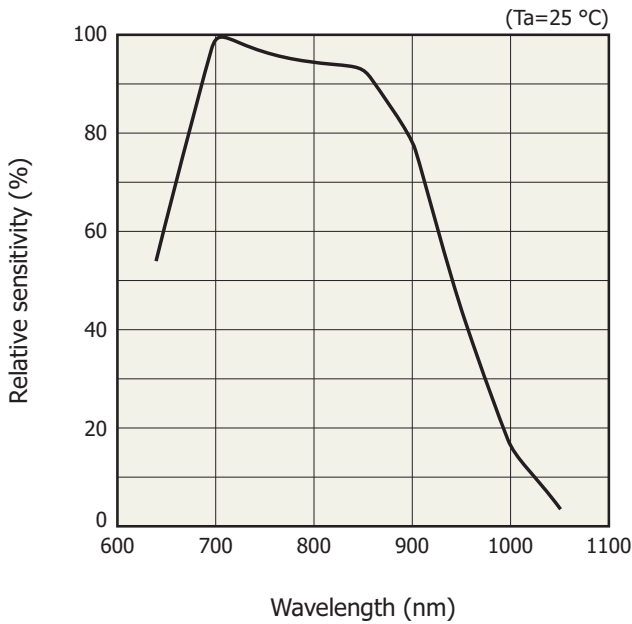

KACCB0545EA

Spectral resolution vs. wavelength (typical example)

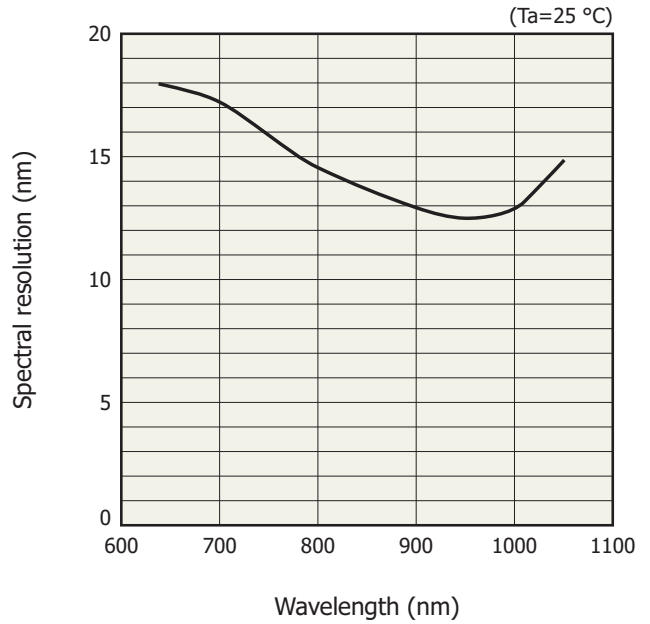

KACCB0541EA

▣ Spectral stray light characteristics (typical example)

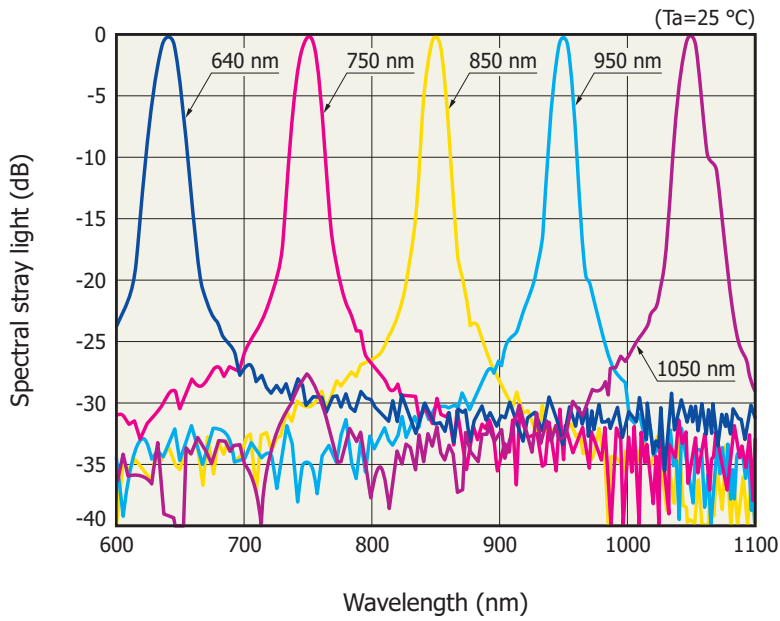

KACCB0542EA

▣ Recommended driver circuit example

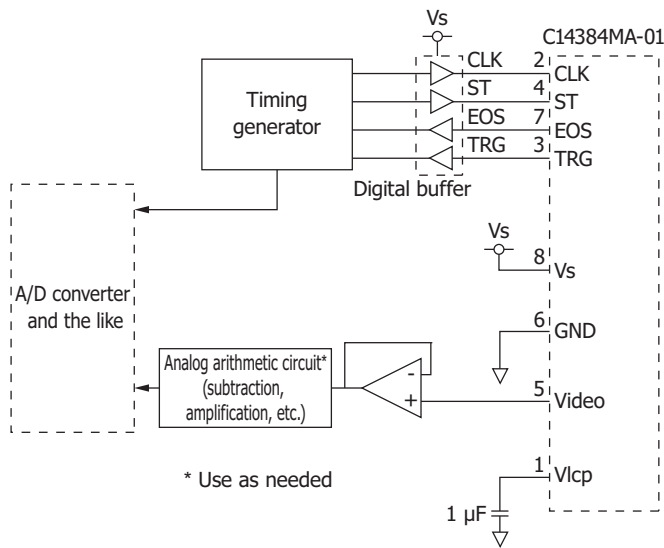

KACCC0919EA

Dimensional outline (unit: mm)

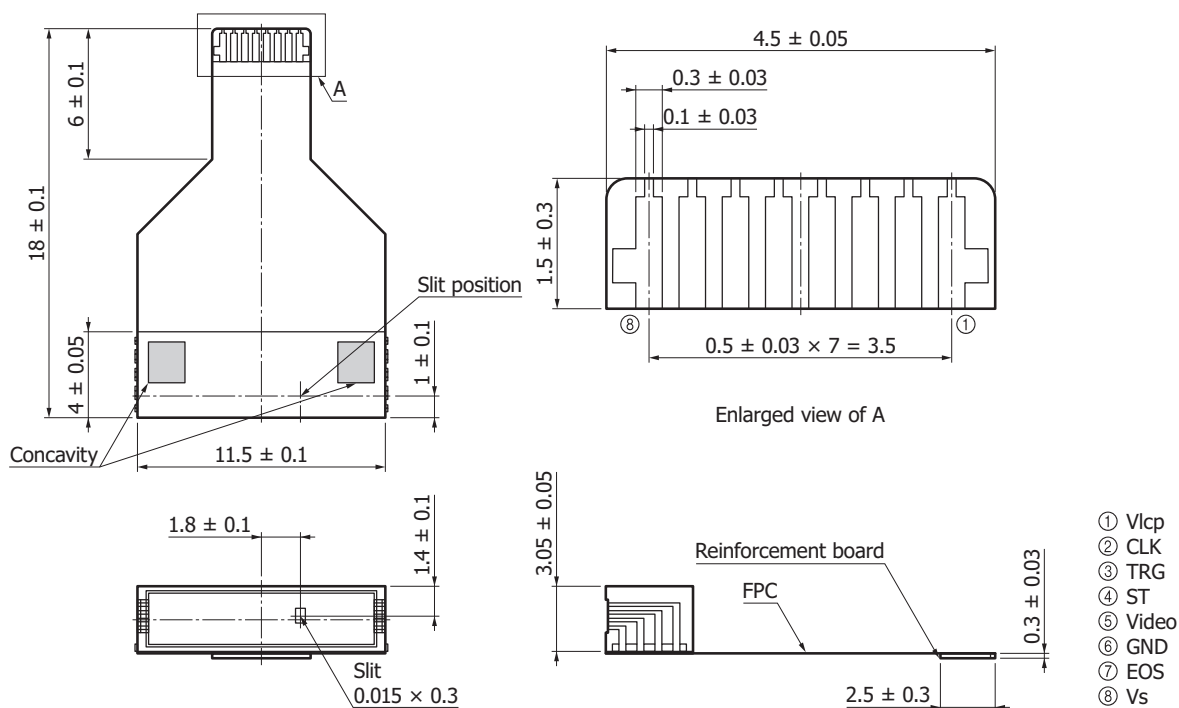

Note: Do not use the gray parts (concavities) shown above. Their shapes and positions may be changed.

KACCA0425ED

Pin connections

Pin no.	Symbol	Name	I/O	Description
1	Vlcp	Bias voltage for negative voltage circuit*14	I	
2	CLK	Clock pulse	I	Sensor clock pulse
3	TRG	Trigger pulse	O	Pulse for acquiring sensor video signals
4	ST	Start pulse	I	Sensor start pulse
5	Video	Video output	O	Sensor video output
6	GND	Ground	-	Sensor GND
7	EOS	End of scan	O	End of sensor scan
8	Vs	Supply voltage	I	Power supply for sensor: 5 V

*14: Approximately -1.5 V generated by the negative voltage circuit inside the image sensor is output to this pin. Because the voltage must be maintained, insert a capacitor around 1 μ F between Vlcp and GND.

Timing chart

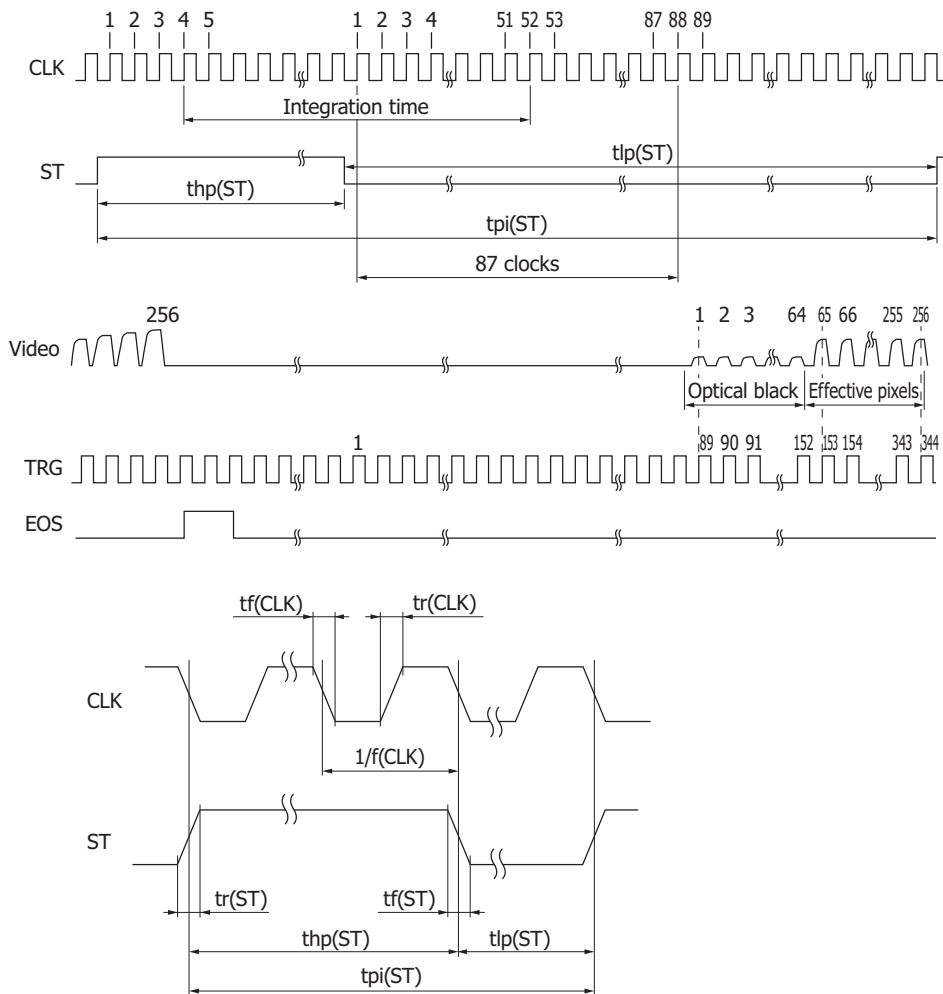

KACCC0920EA

Parameter	Symbol	Min.	Typ.	Max.	Unit
Start pulse period*15	tpi(ST)	349/f(CLK)	-	-	s
High start pulse period*16	thp(ST)	6/f	-	-	s
Low start pulse period	tlp(ST)	343/f	-	-	s
Start pulse rise/fall times	tr(ST), tf(ST)	0	10	30	ns
Clock pulse duty	-	45	50	55	%
Clock pulse rise/fall times	tr(CLK), tf(CLK)	0	10	30	ns

*15: Shortest period necessary for outputting the video signal of all pixels

*16: The integration time corresponds to high ST period + 48 CLK cycles.

The shift register starts operating at the rising edge of the CLK immediately after ST becomes low.

The integration time can be changed by changing the ratio of the high and low periods of ST.

If the first TRG after ST becomes low is considered to be the first signal, acquire the Video at the rising edge of the 153th TRG signal.

If you want to acquire data including the optical black pixels, acquire the Video at the rising edge of the 89th TRG signal.

❏ Operation example

Example in which the clock pulse frequency is set to maximum (video data rate also at maximum), the time of the scan is set to minimum, and the integration time is set to maximum

- Clock pulse frequency [f(CLK)] = Video data rate
= 5 MHz
- Start pulse period [tpi(ST)] = $349/f(\text{CLK})$
= $349/5 \text{ MHz}$
= 69.8 μs
- Minimum low start pulse period [tlp(ST)] = $343/f(\text{CLK})$
= $343/5 \text{ MHz}$
= 68.6 μs
- High start pulse period [thp(ST)] = Start pulse period [tpi(ST)] - Minimum low start pulse period [tlp(ST)]
= 69.8 μs - 68.6 μs
= 1.2 μs

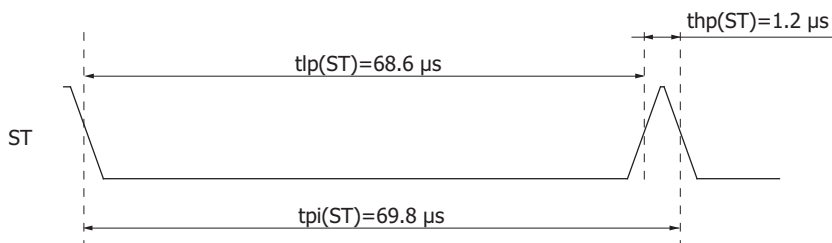

KACCC0921EA

Because the integration time is equivalent to high start pulse period + the period of 48 clock pulses, we obtaine 1.2 μs + 9.6 μs = 10.8 μs .

C14384MA-01 evaluation kit (C14989 + C15036)

The C14384MA-01 evaluation kit (C14989 + C15036) allows you to easily evaluate the C14384MA-01 characteristics. The C14989 is an evaluation circuit (with evaluation software and cable for connecting to the C15036). The C15036 is a mini-spectrometer (C14384MA-01) head. You can connect the C14989 to a PC using the A9160 USB cable (AB type, sold separately), and evaluate the C14384MA-01 characteristics using the evaluation software.*17



Features

→ Initial evaluation circuit for the C14384MA-01 mini-spectrometer

→ The wavelength conversion factor of the mini-spectrometer can be entered from a PC*18

→ High A/D resolution (16-bit)

→ Operated only with USB power supply

*17: Compatible OS:

Microsoft® Windows® 7 Professional SP1 (32-bit, 64-bit)

Microsoft Windows 8 Professional (32-bit, 64-bit)

Microsoft Windows 10 (32-bit, 64-bit)

Microsoft and Windows are registered trademarks of Microsoft Corporation in the United States and/or other countries.

*18: When shipped from the factory, the C14989 contains a typical wavelength conversion factor. To measure with high wavelength accuracy, you need to enter the wavelength conversion factor written in the final inspection sheet included with the circuit with the mini-spectrometer (C15036) for each product.

Electrical characteristics (C14989)

Parameter	Specification	Unit
Interface	USB 2.0	-
A/D conversion	16	bit
Clock pulse frequency	5	MHz
Video rate	5	MHz
Integration time	11 to 1000000	μs

Structure

Parameter	Specification	Unit
Compatible spectrometers	C14384MA-01	-
Dimensions	Evaluation circuit	90 × 70
	Circuit with mini-spectrometer	35 × 40

Absolute maximum ratings

Parameter	Condition	Values	Unit
Operating temperature	No dew condensation*19	+5 to +40	°C
Storage temperature	No dew condensation*19	-20 to +70	°C

*19: When there is a temperature difference between a product and the surrounding area in high humidity environment, dew condensation may occur on the product surface. Dew condensation on the product may cause deterioration in characteristics and reliability.

Note: Exceeding the absolute maximum ratings even momentarily may cause a drop in product quality. Always be sure to use the product within the absolute maximum ratings.

Related information

www.hamamatsu.com/sp/ssd/doc_en.html

■ Precautions

- Disclaimer

■ Technical information

- Mini-spectrometer

Information described in this material is current as of November 2019.

Product specifications are subject to change without prior notice due to improvements or other reasons. This document has been carefully prepared and the information contained is believed to be accurate. In rare cases, however, there may be inaccuracies such as text errors. Before using these products, always contact us for the delivery specification sheet to check the latest specifications.

The product warranty is valid for one year after delivery and is limited to product repair or replacement for defects discovered and reported to us within that one year period. However, even if within the warranty period we accept absolutely no liability for any loss caused by natural disasters or improper product use. Copying or reprinting the contents described in this material in whole or in part is prohibited without our prior permission.

HAMAMATSU

www.hamamatsu.com

HAMAMATSU PHOTONICS K.K., Solid State Division

1126-1 Ichino-cho, Higashi-ku, Hamamatsu City, 435-8558 Japan, Telephone: (81)53-434-3311, Fax: (81)53-434-5184

U.S.A.: Hamamatsu Corporation: 360 Foothill Road, Bridgewater, N.J. 08807, U.S.A., Telephone: (1)908-231-0960, Fax: (1)908-231-1218, E-mail: usa@hamamatsu.com

Germany: Hamamatsu Photonics Deutschland GmbH: Arzbergerstr. 10, D-82211 Herrsching am Ammersee, Germany, Telephone: (49)8152-375-0, Fax: (49)8152-265-8, E-mail: info@hamamatsu.de

France: Hamamatsu Photonics France S.A.R.L.: 19, Rue du Saule Trapu, Parc du Moulin de Massy, 91882 Massy Cedex, France, Telephone: (33)1 69 53 71 00, Fax: (33)1 69 53 71 10, E-mail: infos@hamamatsu.fr

United Kingdom: Hamamatsu Photonics UK Limited: 2 Howard Court, 10 Tewin Road, Welwyn Garden City, Hertfordshire AL7 1BW, United Kingdom, Telephone: (44)1707-294888, Fax: (44)1707-325777, E-mail: info@hamamatsu.co.uk

North Europe: Hamamatsu Photonics Norden AB: Torshamnsgatan 35 16440 Kista, Sweden, Telephone: (46)8-509 031 00, Fax: (46)8-509 031 01, E-mail: info@hamamatsu.se

Italy: Hamamatsu Photonics Italia S.r.l.: Strada della Moia, 1 int. 6, 20020 Arese (Milano), Italy, Telephone: (39)02-93 58 17 33, Fax: (39)02-93 58 17 41, E-mail: info@hamamatsu.it

China: Hamamatsu Photonics (China) Co., Ltd.: B1201, Jiaming Center, No.27 Dongsanhuan Beilu, Chaoyang District, 100020 Beijing, P.R.China, Telephone: (86)10-6586-6006, Fax: (86)10-6586-2866, E-mail: hpc@hamamatsu.com.cn

Taiwan: Hamamatsu Photonics Taiwan Co., Ltd.: 8F-3, No. 158, Section2, Gongdao 5th Road, East District, Hsinchu, 300, Taiwan R.O.C. Telephone: (886)3-659-0080, Fax: (886)3-659-0081, E-mail: info@hamamatsu.com.tw