



Before use, please take the time to read this datasheet and make sure you understood the advices and caution of use.



User Security

- Do not disassemble or modify the chamber. Doing so may result in fire or electric shock.
- Make sure that the chamber is free of moisture or any liquid. Exposure to water or other liquid may result in fire or electric shock.
- Do not touch the plugs or switches with wet hands. Doing so may result in electric shock.
- Before connecting or disconnecting cables, make sure that the power switch is turned OFF. Failure to do so may result in fire, electric shock, or breakdown in the UV LED lamp. Before moving the chamber, disconnect all cables.
- If an abnormal condition, such as smoking, abnormal heating, abnormal odor, or noise, occurs, stop using the chamber immediately and turn OFF the power switch. Continued use may result in fire or electric shock.
- Do not place the chamber in direct sunlight or in a very humid environment. Doing so may result in fire due to internal temperature rise. Observe the limitations of the operating temperature and humidity.
- Do not install the chamber perpendicularly. Always place the chamber on a stable and flat surface. Not doing so may result in the chamber falling or toppling, which may cause bodily injury or chamber malfunction.
- Do not pile up the chambers. Doing so may result in fire due to internal temperature rise.
- Use a cable manufactured by UWAVE to connect the UV LED lamp. Use irradiators that are suitable for the chamber ratings. Doing so may cause control unit failure.
- Please secure a wiring space to the back panel and respect bending radius of cables. Damaging the cables may result in fire or electric shock.

Any incorrect use cancels the warranty.

Table of contents

User Security	1
Eyes & Skin Safety	3
Legal obligations	4
Possible health damages	4
Protective equipment	5
Technical Overview	8
Names and functions of parts	9
Optical characteristics	10
Mechanical dimensions	13
How to use: QUICK START	14
How to use: DETAILS	15



Eyes & Skin Safety

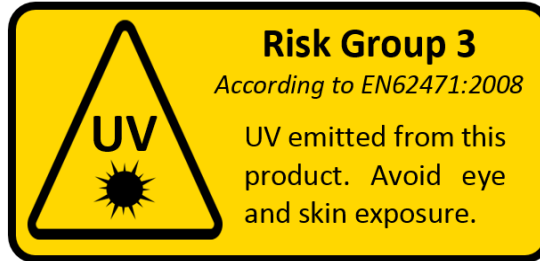

UWAVE products come under the standard DIN EN 62471:2008 which classified sources of optical radiation into risk groups subject to their potential photo biological hazard. Due to the emission of high UV irradiation, our products belong to Risk Group 3 (hazardous even for momentary exposure) therefore special safety measures, detailed in the following, must be observed.



To protect the eyes and skin staff everyone in the area must wear **protective equipment**. Protective **goggles** should comply with the standard EN 170 (Personal eye-protection - Ultraviolet filters - Transmittance requirements and recommended use). The goggles must protect eyes against direct and side irradiation.



Don't look directly at the product's output window because of a risk of becoming blind. Don't expose skin too long without protection to avoid skin burning or cancer.



Due to the high emission power, the area near the LEDs can reach high temperature during operation. Avoid touching directly the product and especially the output window.



Legal obligations

Under the law at present, workers' exposure must be lower than the Exposure Limit Value (Directive 2006/25/EC of the European Parliament). Depending on the wavelength of the product and the body part insolated, **Limit Values are summarized in the tables below:**

	Eye	Skin
Wavelength	315 – 400 nm (UVA)	180 – 400 nm (UVA, UVB, UVC)
Exposure Limit Value	10 000 J/m ²	30 J/m ²

Case study with a LED at 365 nm with an Optical Power of 10 mW/cm²:

For the **eyes**, the maximal exposure time (Δt), the Exposure Limit Value (ELV), and the Optical Power (P) of a UV product are linked by the formula:

$$\Delta t = \frac{ELV}{P}$$

For **skin**, the Optical Power is normalized by skin's sensitivity factors for each wavelength. The maximal exposure time per day is calculated below:

	Eyes	Skin
Optical Power (normalized for skin)	10 mW/cm ²	4,7 μW/cm ²
Maximal exposure time per day	1 min 40 s	12 min

With a UV product with an optical power of 10 mW/cm², the Exposure Limit Value per day is **reached in 2 minutes for eyes and 12 minutes for skin** without any safety equipment. Therefore, protective equipment is needed when a UWAVE UV LED equipment is used.



Possible health damages

Effects on skin along unprotected UV exposure

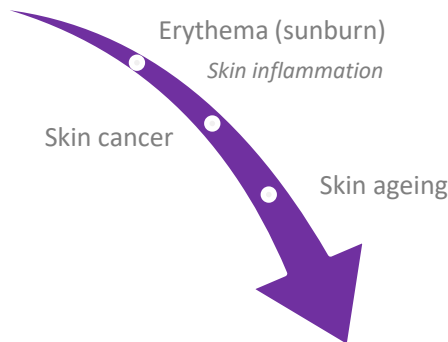

Burning, inflammation, chronic diseases

Effects on eyes along unprotected UV exposure

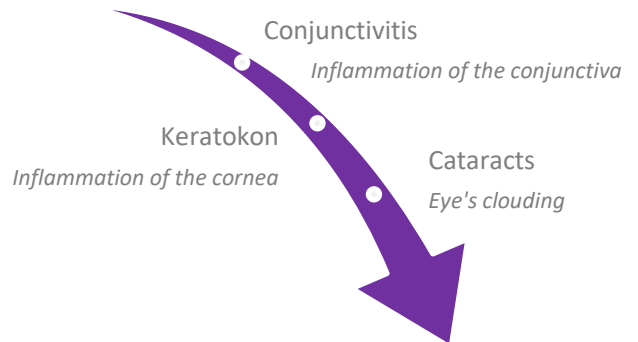

Visual strain, inflammation, blindness



Protective equipment



Eyes protection



Safety goggles prevent UV damages to eyes.

REF: UGLASS-02

- Certified NF EN 170 absorbing 99,9% of UV radiation and visible light up to 532nm
- Protect against side irradiation
- Resist to chemical products and scratches

Beyond 2 minutes per day of eye UV LED exposure at 10 mW/cm², protective goggles are necessary according to the European Directive 2006/25/EC.



Safety face shield prevents UV damages to eyes and skin's face.

REF: UMASK-01

- Certified NF EN 170 absorbing 99,9% of UV radiation and visible light up to 400nm
- Protect against side irradiation
- Resist to scratches

Beyond 12 minutes per day of face UV LED exposure at 10 mW/cm², protective mask is necessary according to the European Directive 2006/25/EC.



Body protection



Safety gloves prevent UV damages to exposed skin.

REF: UGLOVE-01

- High protection against UV radiation
- Resist to chemical products and scratches

Beyond 12 minutes per day of hands UV LED exposure at 10 mW/cm², protective gloves are necessary according to the European Directive 2006/25/EC.



Safety jacket and trousers prevent UV damages to exposed skin, especially arms & legs.

- Certified UPF 50+ absorbing more than 90% of UV radiation
- Durable and resistant

REF (jacket): UJACK-01

REF (trouser): UTROUS-01

Beyond 12 minutes per day of arms & legs UV LED exposure at 10 mW/cm², protective clothes are recommended according to the European Directive 2006/25/EC.



Protection suit prevents UV damages to entire body, especially neck.

REF: USUIT-01

- Certified UPF 50+ absorbing more than 90% of UV radiation
- Resist to chemical products

Beyond 12 minutes per day of neck UV LED exposure at 10 mW/cm², protective suit is recommended according to the European Directive 2006/25/EC.



UV source isolation

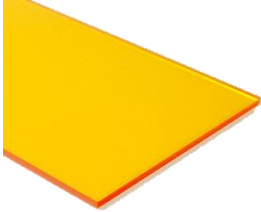

UV shields are protective windows which isolate the UV insulated zone to protect all workers around.

They are made to measure to fit with your constraints.

REF: USHIELD-01

Beyond 2 minutes per day of eye UV LED exposure and 12 minutes of skin UV exposure at 10 mW/cm², protective shields are necessary to protect staff without safety equipment according to the European Directive 2006/25/EC.



Warning stickers



Warning stickers inform workers of radiation danger and invite them of wearing protection equipment. They are available in 3 sizes:

- 55 mm x 25 mm
- 165 mm x 75 mm
- 290 mm x 130 mm

REF: USTICK-01

REF: USTICK-02

REF: USTICK-03



Expertise

Our UV LED experts from UWAVE can come and check your production lines to:



Measure UV irradiance to **determine the maximum UV personal exposure time** compared with limits (European Directive 2006/25/EC).



Determine the most **adapted solution** to protect workers' eyes and skin.







Contact us to get our expertise. We will find together the equipment which fits with your application.



Technical Overview

The UV CHAMBER™ allows repeatable polymerization process thanks to a homogeneous illuminated area and an easy-to-use system. It is available in 2 versions:

- The UV CHAMBER™ which includes a UCUBE™ 25 LEDs, that can provide an irradiance of 250 mW/cm² at 100mm of working distance.
- The UV CHAMBER™ which includes a UCUBE™ 100 LEDs, that can provide an irradiance of 1000 mW/cm² at 100mm of working distance.

Product reference <i>Where XXX is the wavelength</i>		UVCHAMBER-XXX-025	UVCHAMBER-XXX-100
Electronics 	Input power	Single phase 85 to 264 VAC, 50/60 Hz	
	Connector to 220V	IEC C14	
	Output voltage and current	48 VDC and 12.5 A for one channel	
	Inrush current (typ.)	35A at 115 VAC and 70A at 230 VAC	
	Ground leakage current	1.2 mA max at 240 VAC	
	Connector to UV LED product	SUBD 13W3	
	Power consumption	150W	500W
	Illumination mode	Controlled by the user thanks to buttons at the front side of the chamber	
Optics 	Wavelength	365 or 385 or 395 or 405 nm <i>Contact us for other wavelengths (UVA, UVB & UVC).</i>	
	Max Irradiance at 30mm	600 mW/cm ²	1500 mW/cm ²
	Optical option	<i>Can be provided to collimate the light beam. It allows to keep a high irradiance at a higher working distance.</i>	
Mechanics 	Width and length	382 mm x 306 mm	
	Height	605 mm	
	Material	Device body: Aluminum alloy	
	Weight	18 kg (with a UCUBE™ at the top)	
Thermal 	Cooling system	Active air cooling with fans	
Environment 	Working temperature	+10°C to +35°C	
	Working Humidity	< 80% for temp < 30°C	
	IP Code	IP40	
Additional items		Delivered in a special wood case Key x1 pc., Tray x1 pc., 2.5m power cable x1 pc. and instruction guide x1 pc.	



Names and functions of parts

Front side

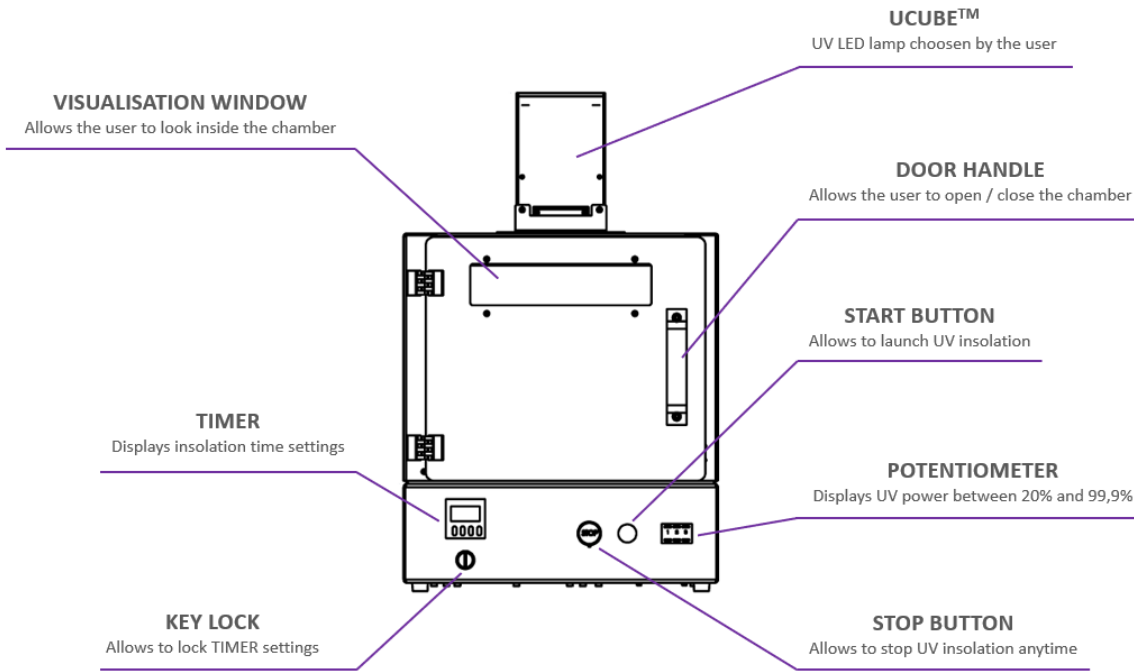

Back side

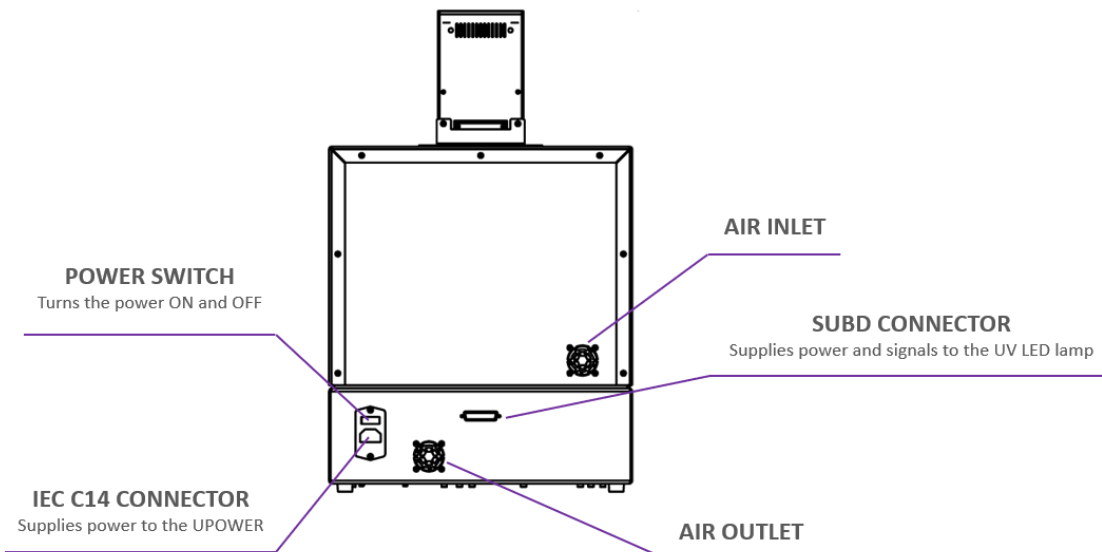



Optical characteristics

Spectra

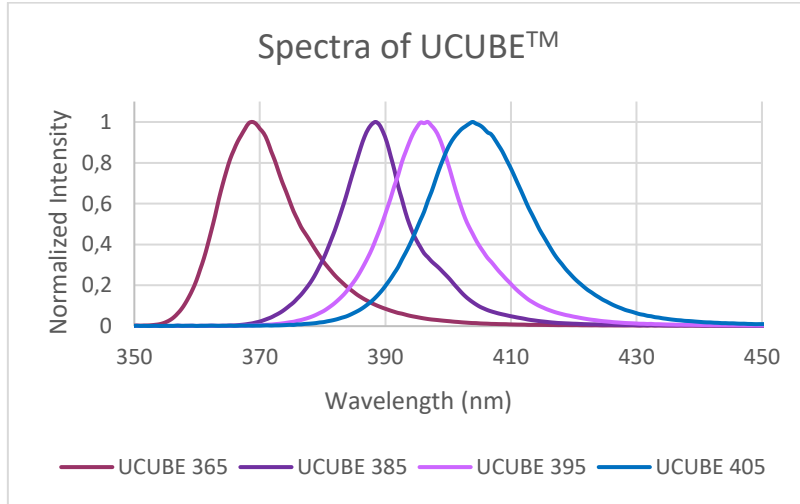

For other wavelengths (IR / VISIBLE / UVA: 325nm, 340nm / UVB: 310nm / UVC: 265nm, 275nm), please contact us.

Option Collimation Optics

The UCUBE™ can be provided with or without optics to improve the collimation of the light beam.

The collimation half-angle of the UCUBE 25 or 100 LEDs with optics has a value of 6°.

This option allows you to increase the irradiance homogeneity.



Photometry: UCUBE 25 LEDs

In the following graph, the area exposed is the area where the irradiance is higher than 50% of the maximum irradiance. The UCUBE™ 25 LEDs with optics is not usable for a working distance smaller than 80mm.

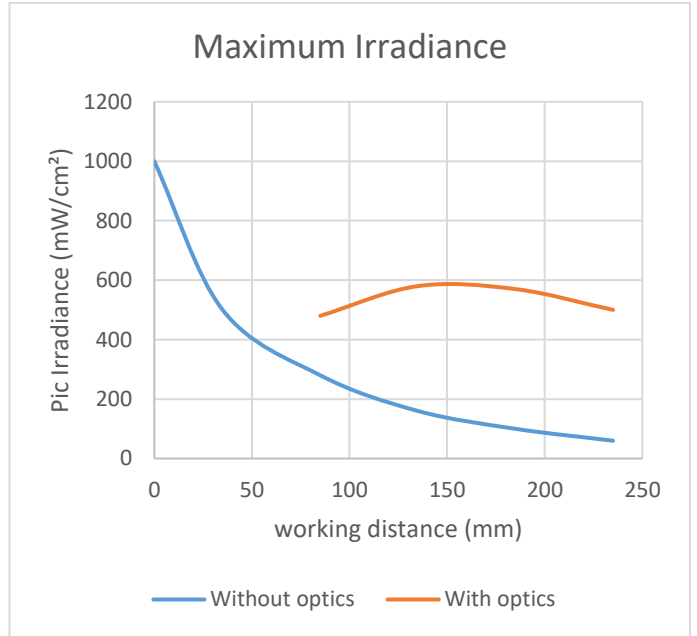
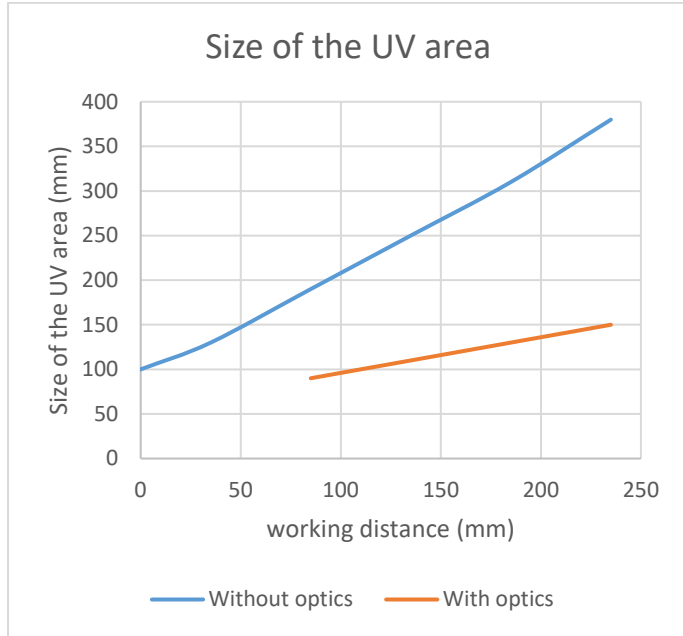

Homogeneity without optics @ 10cm – UCUBE 25 LEDs

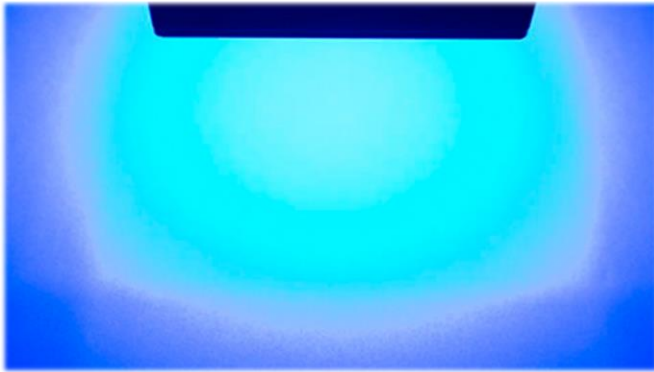

Homogeneity with optics @ 10cm – UCUBE 25 LEDs

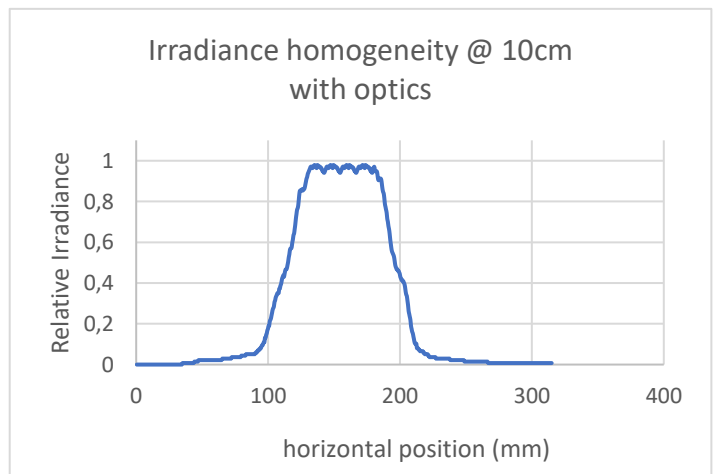
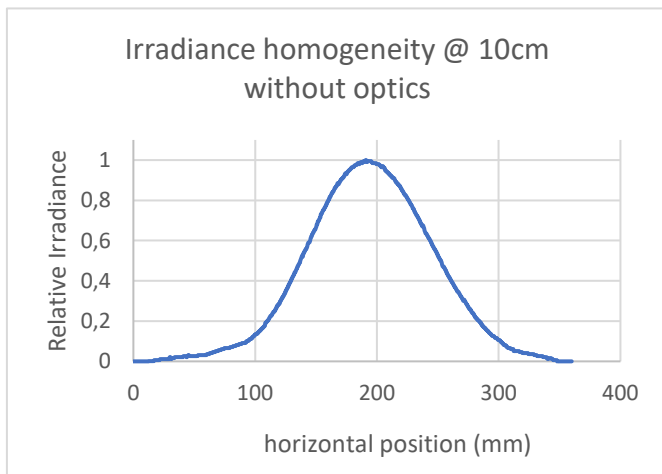
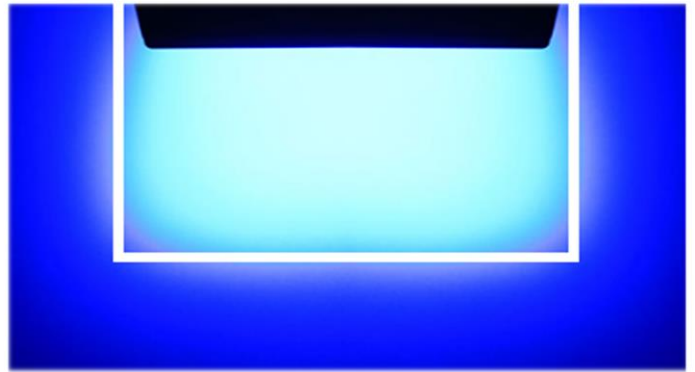

Photometry: UCUBE 100 LEDs

In the following graph, the area exposed is the area where the irradiance is higher than 50% of the maximum irradiance.

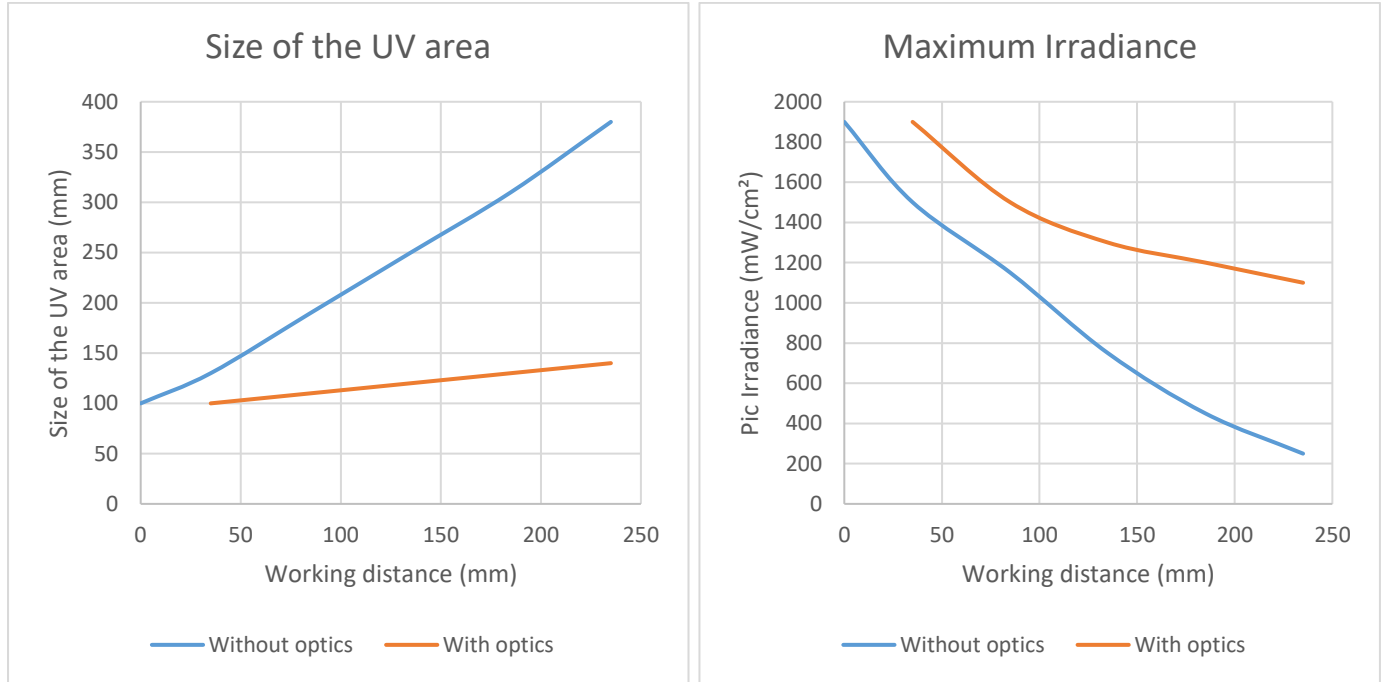



Mechanical dimensions

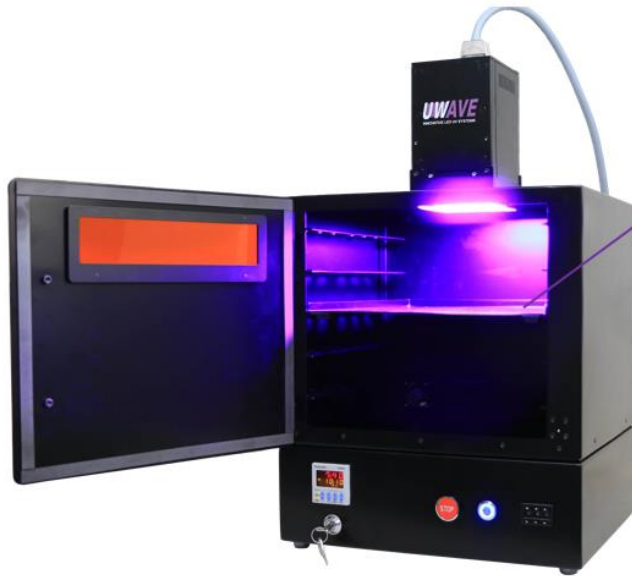
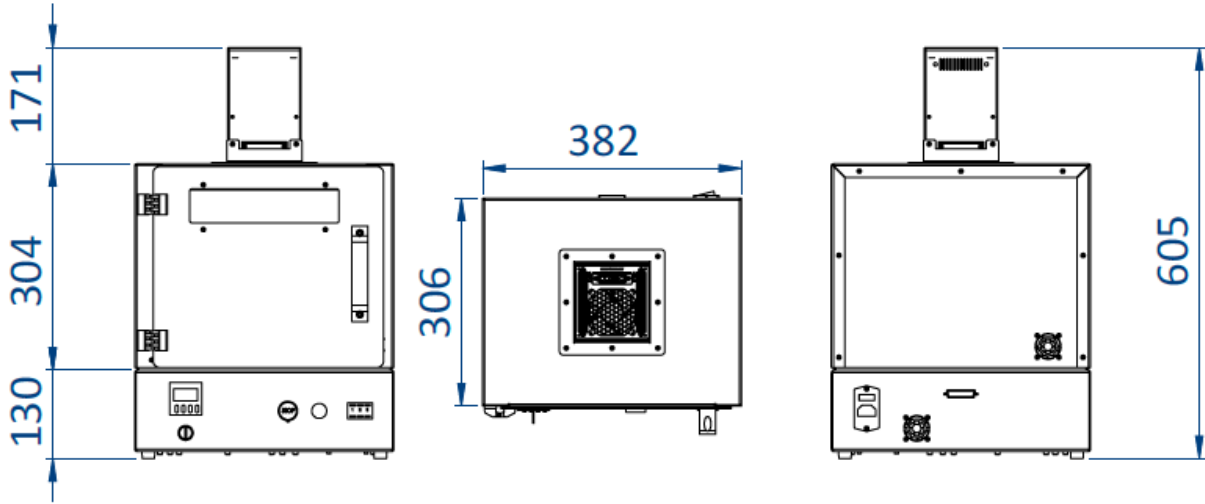

THE TRAY

Allows to place samples to cure at a defined distance from the UV LED lamp.

There are five available positions for the tray in the UVCHAMBER™: 35, 85, 135, 185 and 235 mm



How to use: QUICK START

Follow the steps below to make a quick start with the UV CHAMBER™:

- Place the control unit on a stable and flat location
- Provide sufficient space around the chamber so that the ventilation holes are not blocked (minimum 100mm in all directions).
- Connect the female side of the SUBD13W3 cable to the UCUBE™ and the male side to the chamber SUBD connector. Please notice that both sides of the cable must be screwed for an optimal connection.

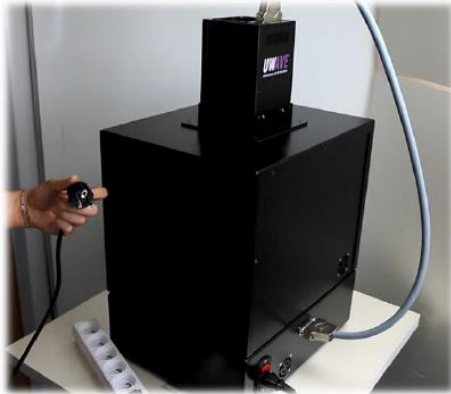

① Ready



② Connect the electrical plug into the socket



③ Push the AC/DC power button



The red button is ON if you plugged well.

④ Check your cabling thanks to the red button

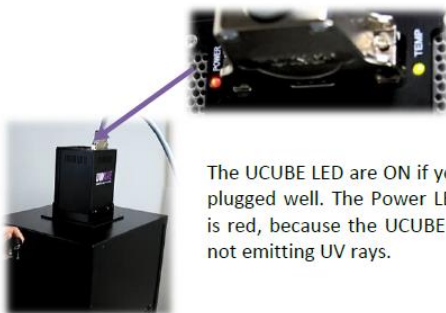

The UCUBE LED are ON if you plugged well. The Power LED is red, because the UCUBE is not emitting UV rays.

⑤ Verify on the UCUBE if the LED are ON



The timer screen is also ON.

⑥ The UV-CHAMBER is now ready to be used



How to use: DETAILS

The steps below explained how to set the irradiation time thanks to the TIMER and how to set the irradiation optical power thanks to the potentiometer.



The red timer is fixed and represents the previous timer chosen. The orange timer is the one that you can change.

① Push the buttons to choose your time



To validate the time (red timer will equal to orange timer that you defined), push the STOP button or push the RESET button.

② Push the STOP button to set up the timer



You can control the light intensity thanks to these buttons. For example, 675 equals to 67,5% and 999 equals to 99,9% of light intensity.

③ Push the buttons to choose the intensity

The blue light means that UV rays are emitted inside the UV-CHAMBER™.

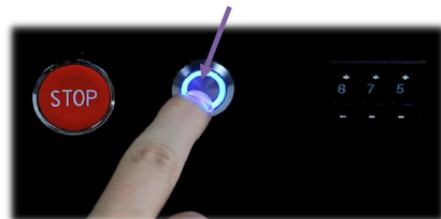

④ Push the START button for emitting UV



⑤ The time is elapsing (red timer)

The power LED becomes green when the UCUBE™ emits UV rays.



Through the safety window of the UV-CHAMBER™ you will be able to see if the UCUBE™ is emitting UV light inside the UV-CHAMBER™.

⑥ Check if the UCUBE™ is emitting UV

Lock option

"LOCK" appears on the screen, when the timer screen is locked.

LOCK



OR

"LOCK" appeared



① Push the LOCK button

② Turn the key to lock the screen timer

Even if you are trying to change the timer it will not work.



No "LOCK" so you can change the time.



③ Cannot change the timer when it is locked

④ Change the timer when it is unlocked

Door security



Someone trying to open the door during insolation.

① The product is shutting down if the door is open



Detect when the door is open, and automatically shut down the UV-CHAMBER™.

② Door security system activated

UCUBE™ Status LED



STATUS	MEANING
POWER & TEMP OFF	The product is not under voltage
POWER red	The product is under voltage but do not emit UV light
POWER green	The product is emitting UV light
TEMP green	The temperature inside the product is OK: the product can be turned on
TEMP red	The temperature of the LED is too high for the product to be turned on